

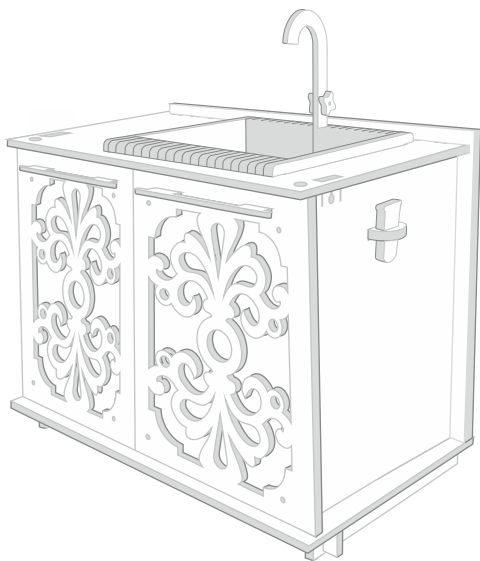

# Zlew Kuchenny

kuchenny z malej litery

INSTRUKCJA MONTAŻU



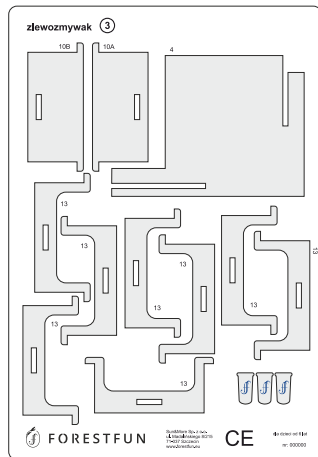
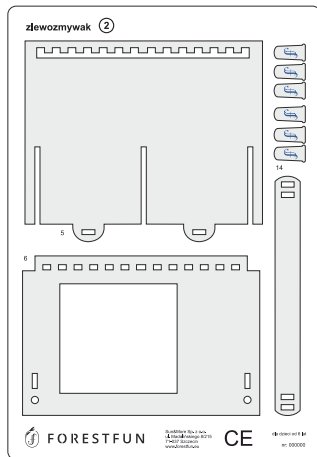
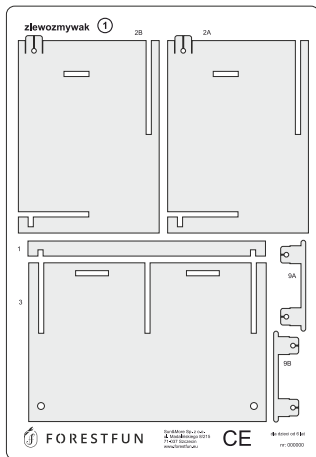

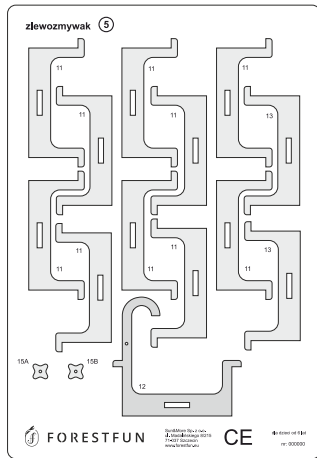
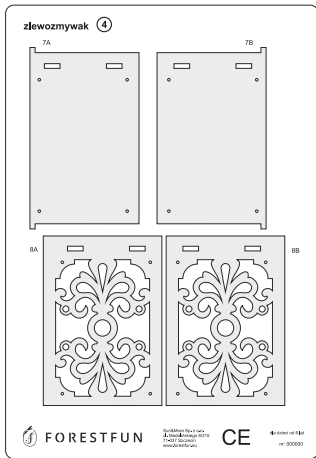

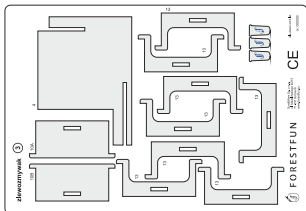
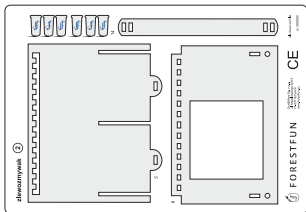
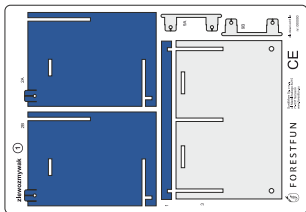

## Krok I

tu też chyba spacja nie potrzebna między łącz a numer

Wybierz zaznaczone elementy. Połącz nr 2 i 3 za pomocą elementu nr 1, wsuwając go od boku i w dół.

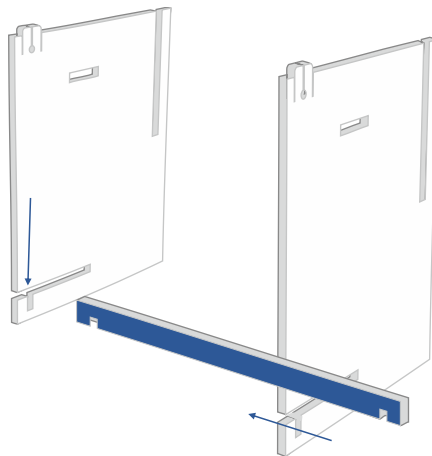

FORESTFUN

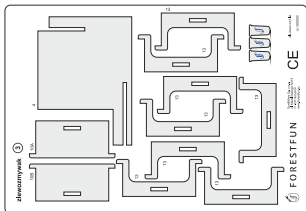
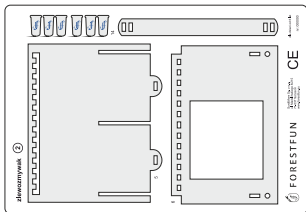
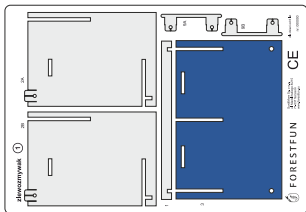

## Krok II

Wybierz zaznaczony element. Wsuń w otwory w bocznych ścianach, jak na rysunku poniżej.

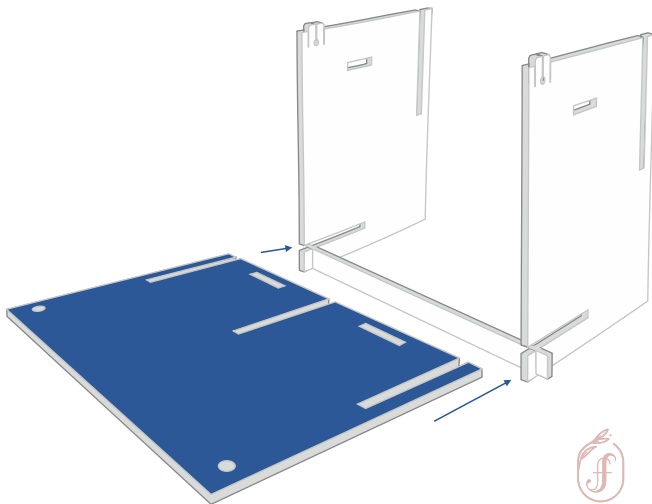

FORESTFUN

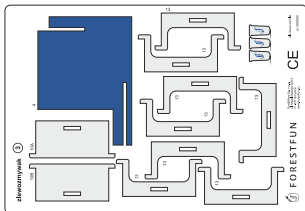
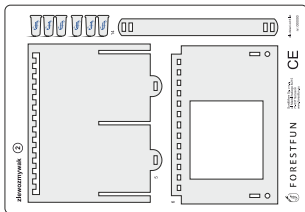
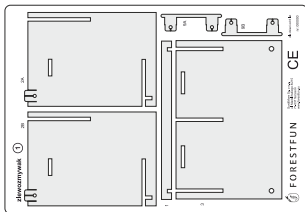

## Krok III

Wybierz zaznaczony element.  
wsuń go w otwór w podstawie.

zmieniłam  
kropkę po  
pierwszym zdaniu  
na „i”

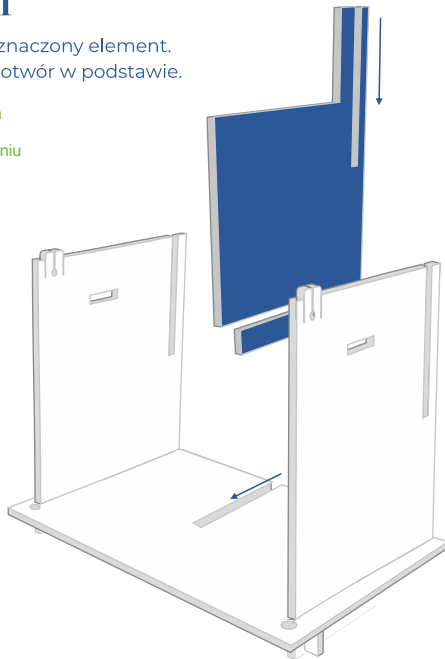

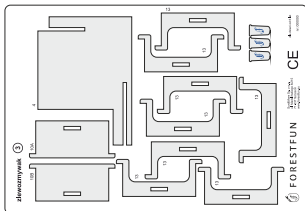
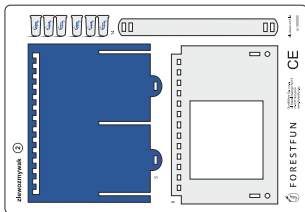
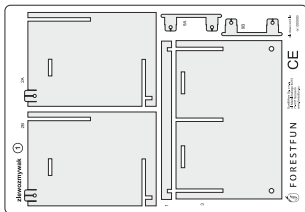

## Krok IV

Wybierz zaznaczony element.  
Wsuń go od góry w otwory  
w bocznych ścianach szafki.

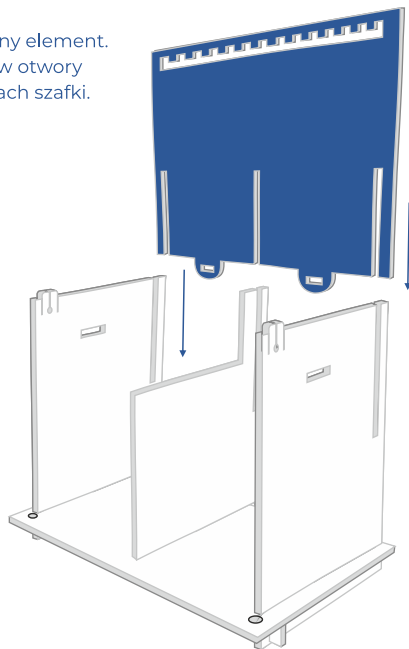

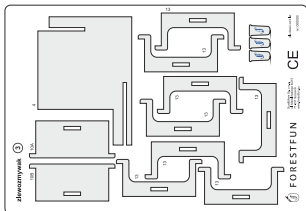
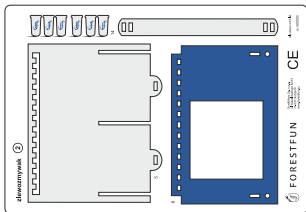
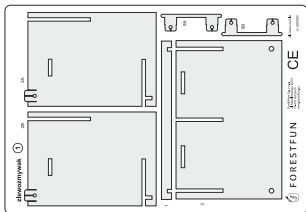

## Krok V

Wybierz zaznaczony element. Wsuń go w otwór w tylnej ścianie, następnie wciśnij w wypustki ścian bocznych.

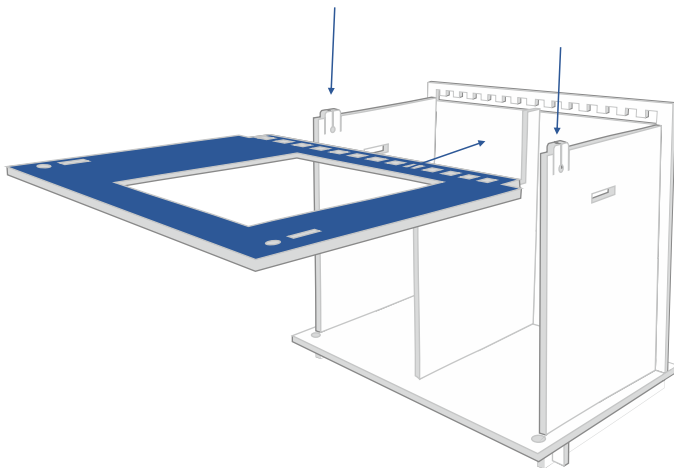



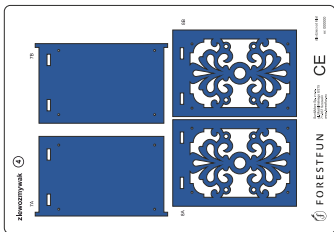
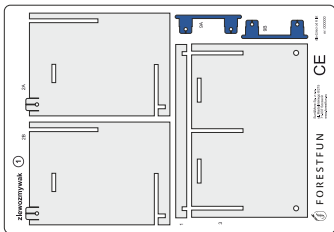

## Krok VI

Za pomocą patyczków połącz ze sobą elementy nr 7A i 8A oraz 7b i 8B. Zamocuj w drzwiczkach uchwyty (nr 9A i 9B.)

7b powinno by chyba z wielkiej litery

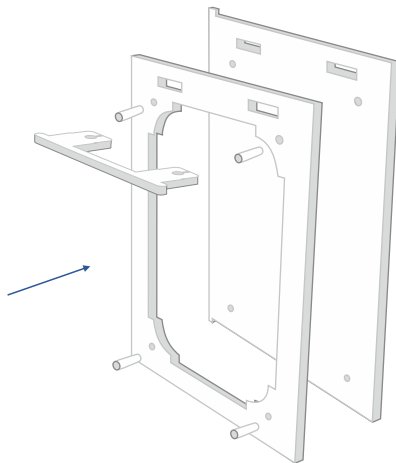

FORESTFUN

## Krok VI

Umieść drzwiczki we wskazanych otworach.

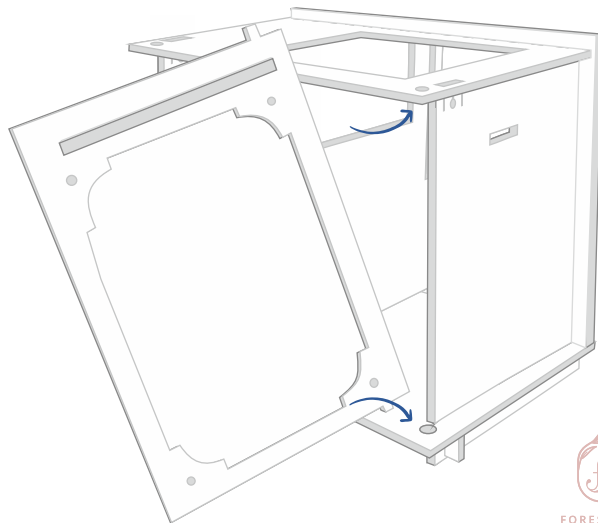
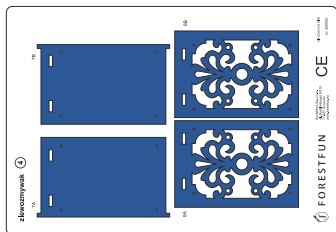
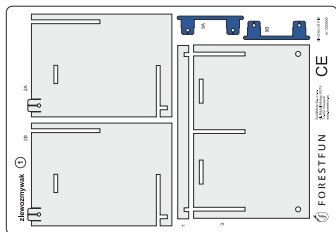

FORESTFUN

## Krok VII

Wybierz zaznaczone elementy. Wsuń je po lewej i po prawej stronie, w otwór w blacie.

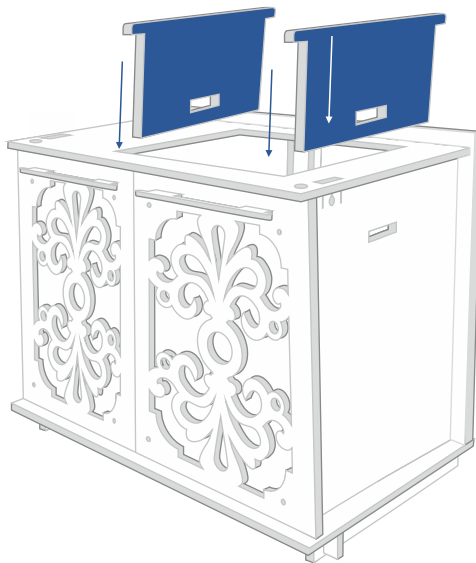
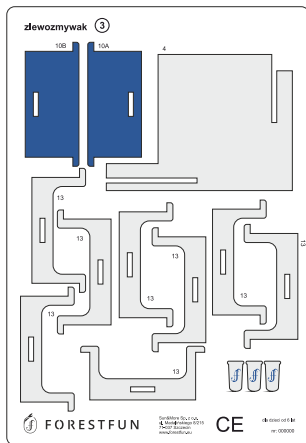

FORESTFUN

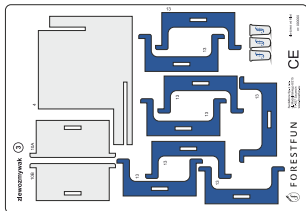
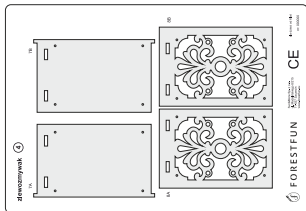
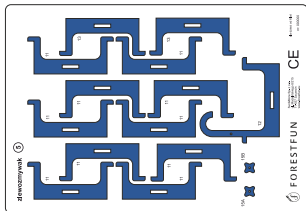

## Krok VIII

Wybierz zaznaczone elementy.  
Elementy nr 11 umieść po lewej stronie otworu w blacie. Następnie zamontuj element nr 12 i kolejno wszystkie elementy nr 13.

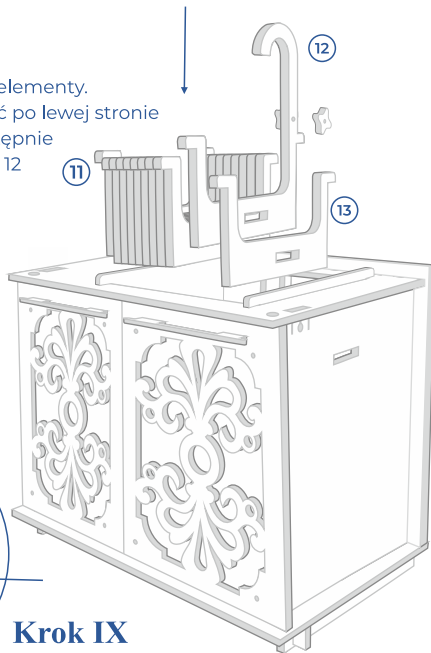

## Krok IX

Przymocuj pokrętła do kranu za pomocą patyczków.

## Krok X

Wsuń listwę w otwór w bocznej ścianie,  
przez całą długość szafki.

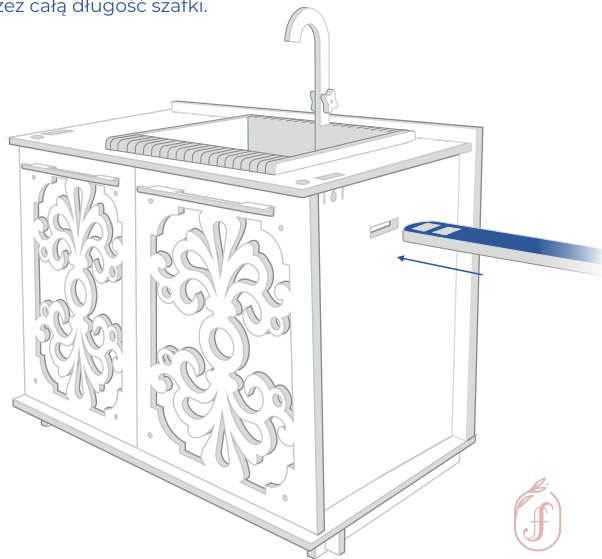
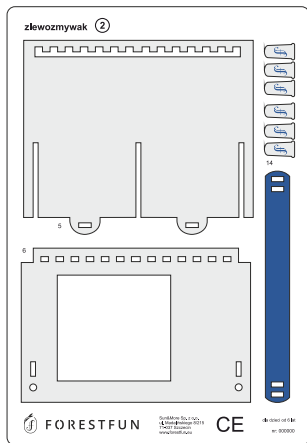

FORESTFUN

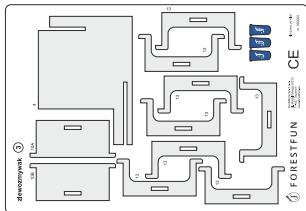
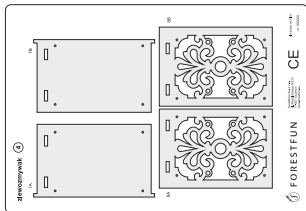
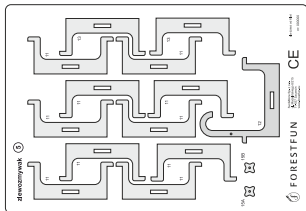

## Krok X

Zabezpiecz listwę klinami, wsuwając je w otwory po zewnętrznej stronie oraz od środka. Nie zapomnij zaklinować pozostałych elementów z tyłu szafki. **Zaklinuj pozostałe elementy z tyłu szafki.**

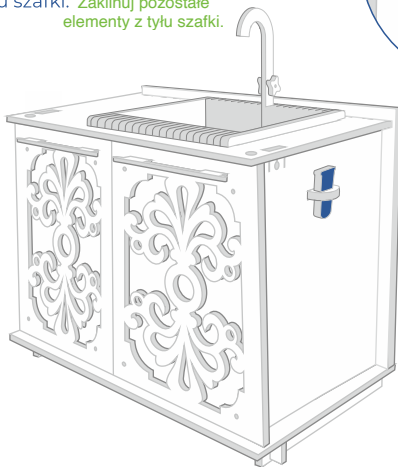
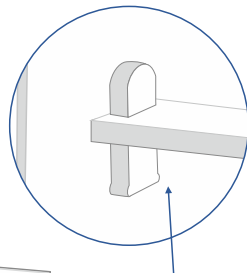

FORESTFUN